

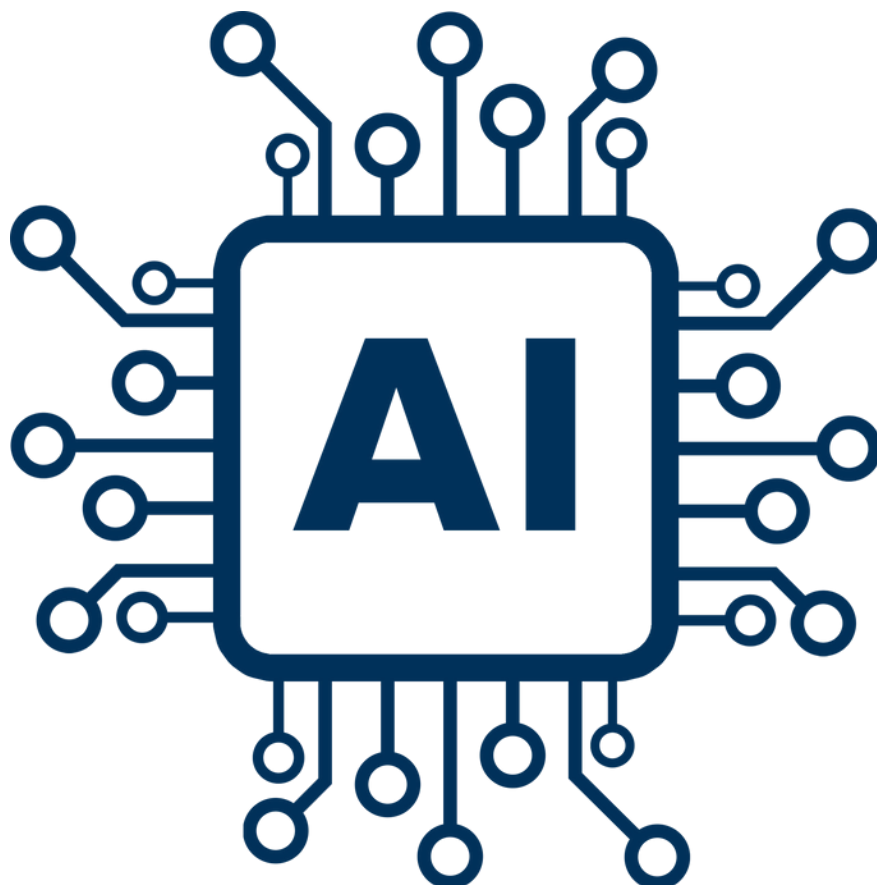

Exaustores RenovAr



**SISTEMA DE INTELIGÊNCIA ARTIFICIAL É UMA
TECNOLOGIA: NA ENGENHARIA DE EXAUSTÃO E
CLIMATIZAÇÃO VENTILAÇÃO.**



ANVISA
Agência Nacional
de Vigilância Sanitária



HAYASHI
SYSTEM



ASSOCIAÇÃO
BRASILEIRA
DE NORMAS
TÉCNICAS



ASHRAE
Associate
Society
Alliance



Exaustores RenovAr

COMO A INTELIGÊNCIA ARTIFICIAL PODE SER APLICADA NA ENERGIA DE EXAUSTÃO VENTILAÇÃO?

A inteligência artificial é uma tecnologia disruptiva aplicada com sucesso em vários campos, como saúde, indústria, logística e atendimento ao cliente, impulsionando a transformação digital em diversos setores e beneficiando o setor de energia e serviços públicos.

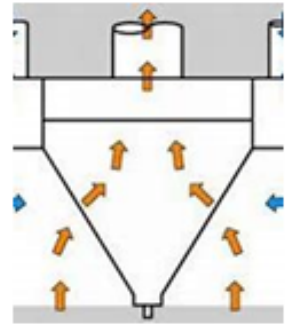
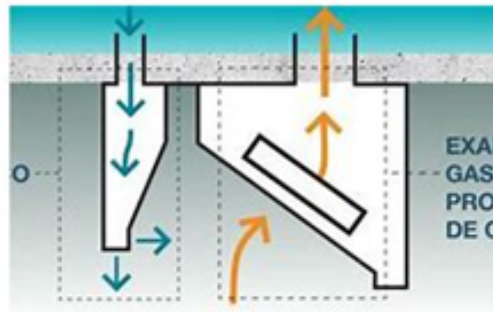
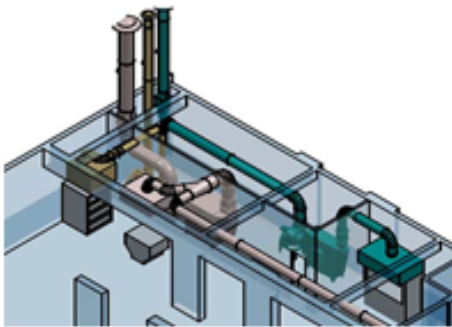

As soluções para energia incluem distribuição, descarbonização e digitalização, que alteram a maneira como as empresas lidam com a energia, permitindo uma gestão eficiente dos recursos.

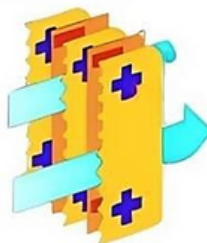

Lâminas com tecnologia Hayashi



Exaustores RenovAr

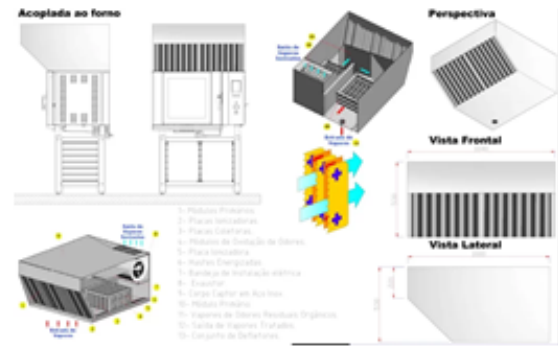
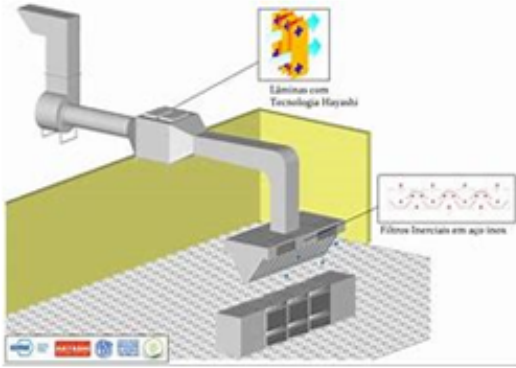

Precipitador modelo vertical

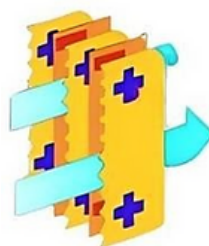
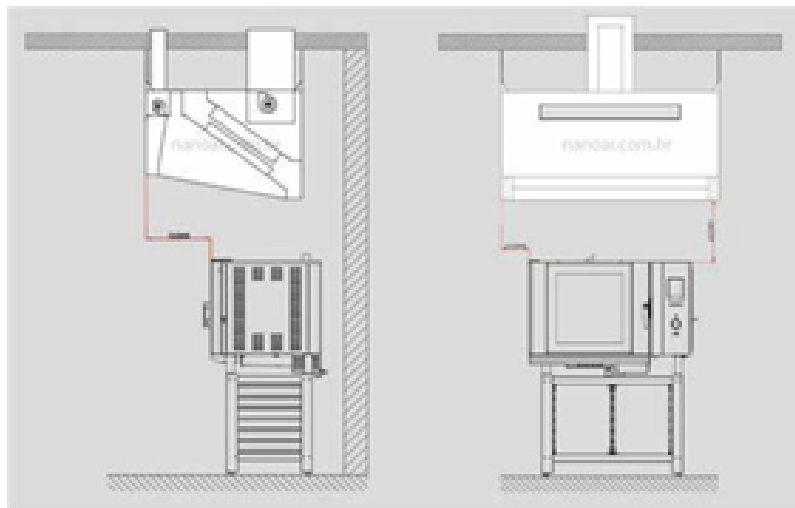
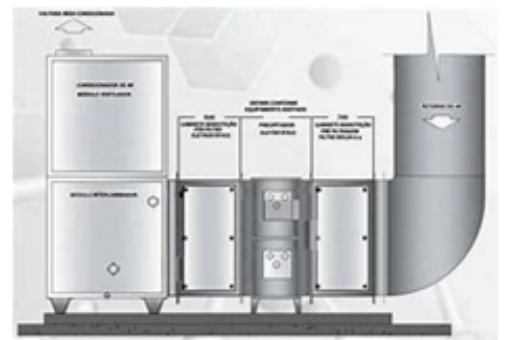

Lâminas com tecnologia Hayashi



Exaustores RenovAr

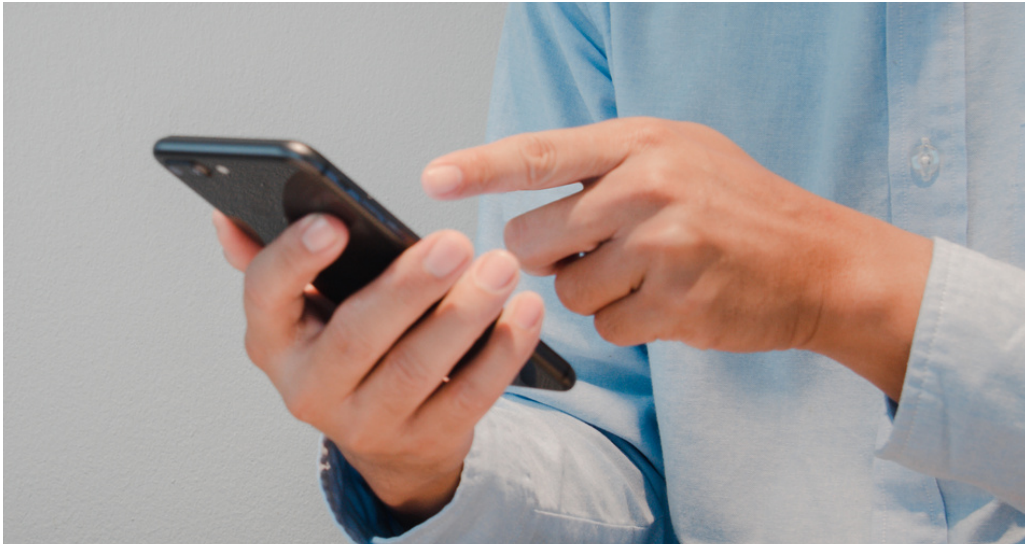

Se interessou por algum produto?

Entre em contato conosco!

(11)932169701

Horário e Atendimento

Segunda à Sexta, 8h00 às 17h00 Sábado, 8h00 ao
12h00

Se preferir, visite nosso Showroom

Rua João de Sousa Dias, 412- Campo Belo- São Paulo



ANVISA
Agência Nacional
de Vigilância Sanitária



HAYASHI
SYSTEM



ASSOCIAÇÃO
BRASILEIRA
DE NORMAS
TÉCNICAS



ASHRAE
Associação
Society
Alliance

TODOS OS PRODUTOS HAYASHI SYSTEM POSSUEM DIREITOS AUTORAIS.



TECNOLOGIA HAYASHI SYSTEM



**Exaustores
RenovAr**