

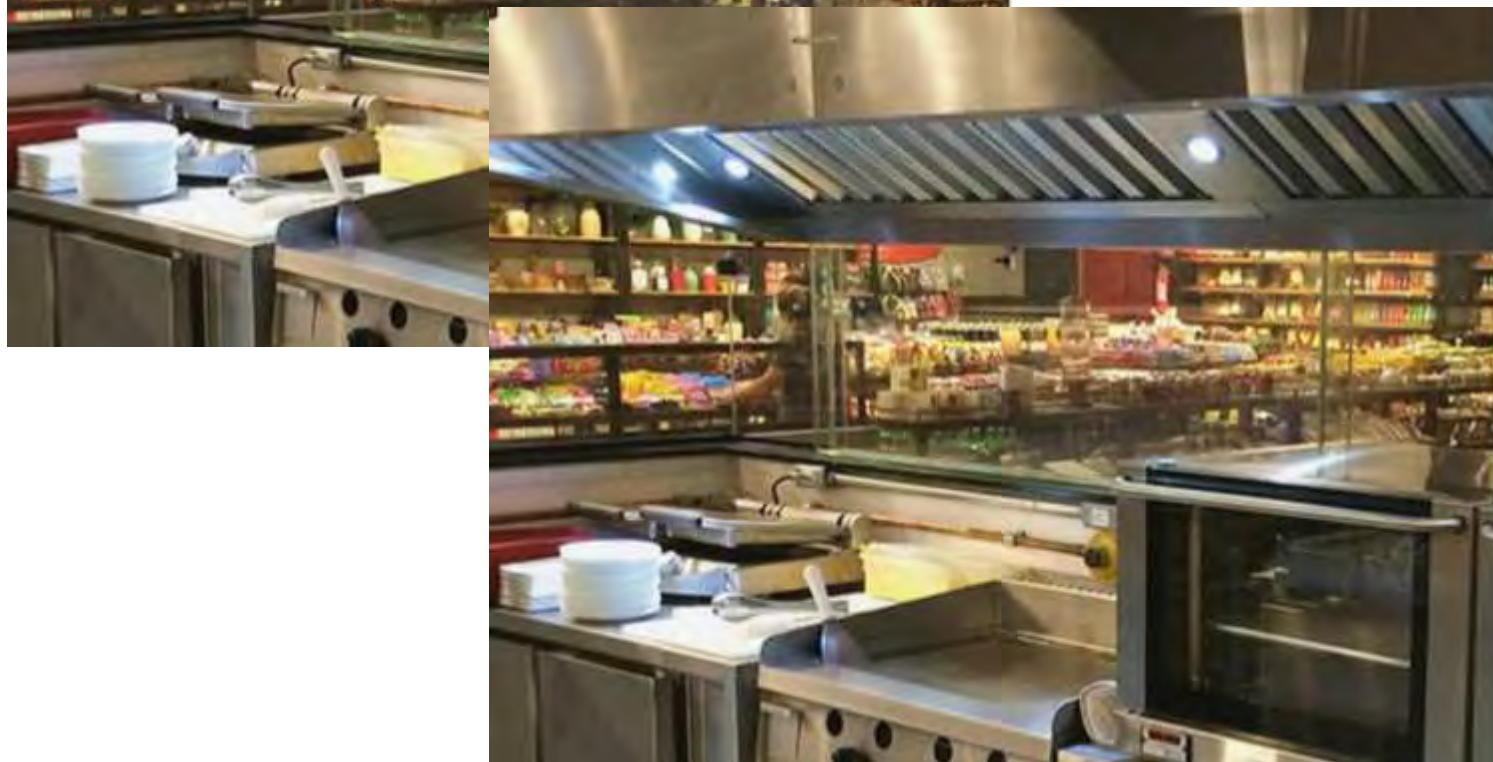

Exaustores RenovAr



ANVISA
Agência Nacional
de Vigilância Sanitária



HAYASHI
SYSTEM



ASSOCIAÇÃO
BRASILEIRA
DE NORMAS
TÉCNICAS



ASHRAE
Associate
Society
Alliance



Quem somos?

Ao longo dos anos, investimos em pesquisa e desenvolvimento para construir uma linha de produtos que se destaca pela tecnologia avançada, especialmente na área de nanotecnologia eletrostática ESP.

Nossa linha de lâminas utiliza a inovadora tecnologia Hayashi, o que nos torna líderes na indústria. Além disso, oferecemos exaustores residenciais e profissionais, filtros eletrostáticos e outros equipamentos de ventilação de exaustão.

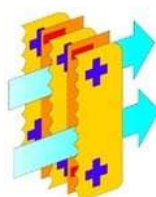

Lâminas com
tecnologia Hayash

Coifas Profissionais

Aplicações

- Blocos de cocção em cozinhas profissionais (fogão, fritadeira, frigideira, chapa quente, char Broiler, Grill, churrasqueira e forno combinado);
- Postos de pintura;
- Braseiro a carvão;
- Módulo primário de remoção de poluentes em aplicações industriais;
- Em diversos segmentos, tais como centros de usinagem de componentes automotivos, farmacêuticos, alimentícios e sais orgânicos.

Graças ao sistema eletrostático integrado da Hayashi, as coifas eletrostáticas podem ser instaladas em espaços apertados sem dutos externos e sem danificar a estrutura. Seu sistema certificado de alta tecnologia é o único que integra a eletrônica ao pneu, reduzindo os custos de instalação e manutenção. As blindagens elétricas profissionais são fabricadas em aço Inox 430 ou aço AISI 304.



HAYASHI
SYSTEM



ASSOCIAÇÃO
BRASILEIRA
DE NORMAS
TÉCNICAS



ASHRAE
Associate
Society
Alliance

Coifa Caixote



Disponível nos modelos parede de Ilha.

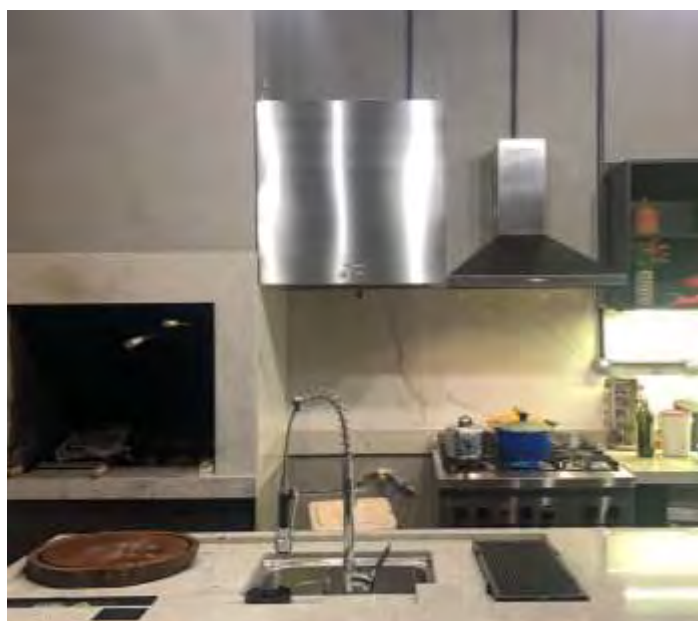

Coifa Caixaote

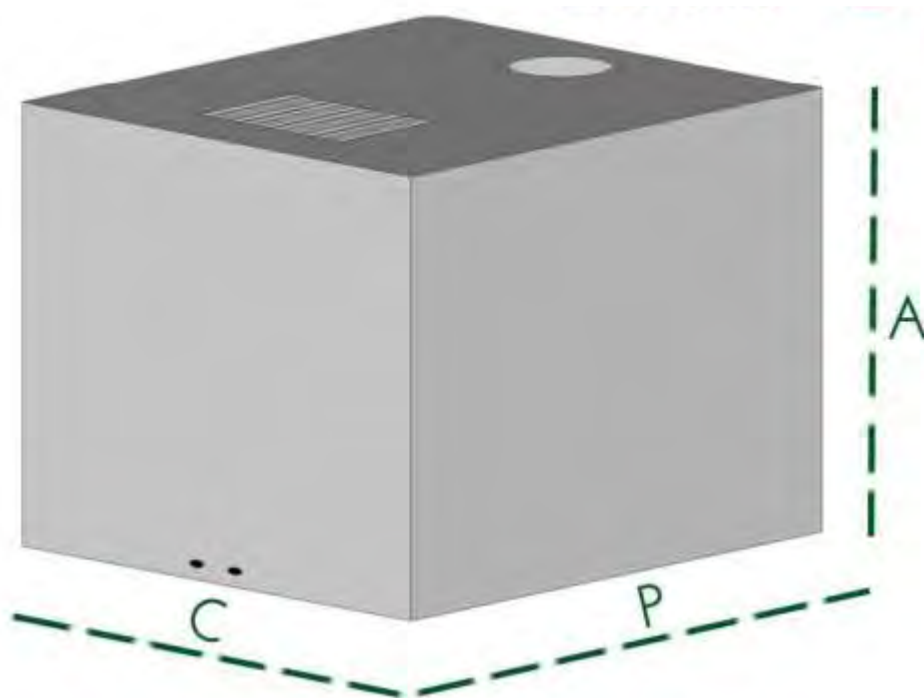

Dimensoes Minimais - COIFA CAIXOTE (parede/ilha)	
Altura (A)	680mm
Comprimento (C)	800mm
Profundidade (P)	800mm
Obs.As Coifas Caixaote podem ser feitas sob medida, consulte-nos.	

Componentes da Coifa Caixaote

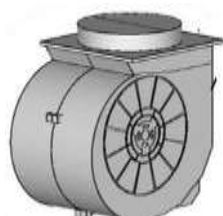

Exaustor
Centrífugo

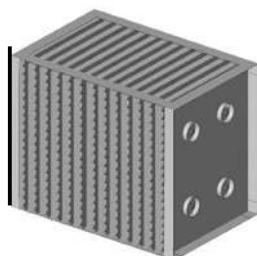

Filtro Eletrostático
ESP

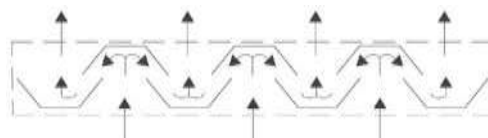

Filtro Inercial

Coifa Frontal



Disponível nos modelos parede de Ilha.



Coifa Frontal

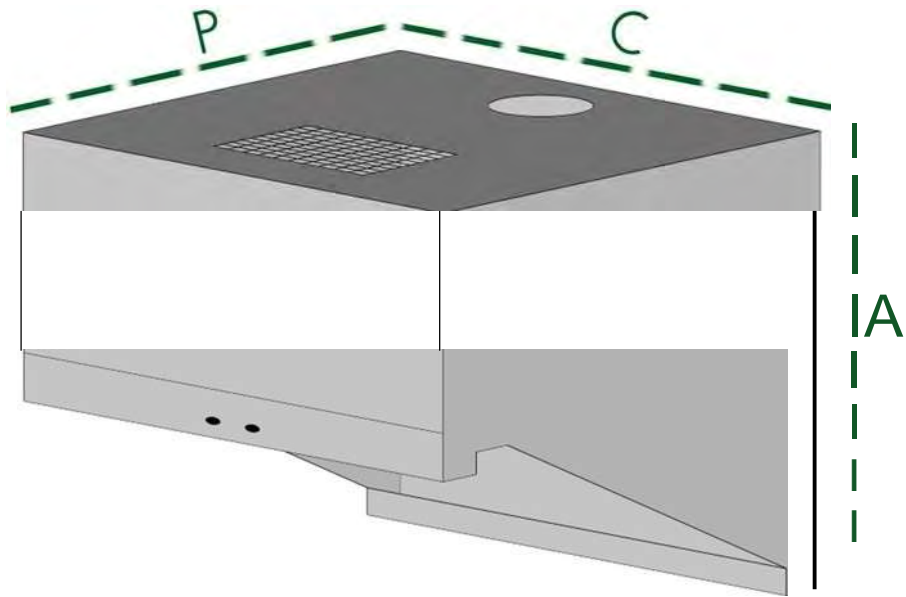

Dimensoes Mfnimas - COIFA FRONTAL (parede/ilha)	
Altura Frente (Af)	680 mm
Altura Tras(At)	450 mm
Comprimento (C)	800 mm
Profundidade (P)	800 mm
Obs. As Coifas Frontais podem ser feitas sob medida, consulte-nos.	

Componentes da Coifa Frontal

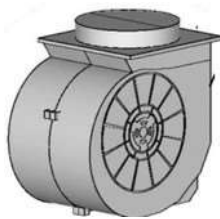

Exaustor
Centrffugo

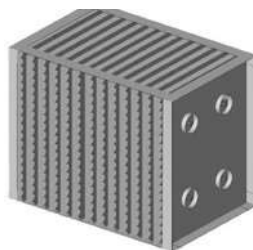

Filtro Eletrostático
ESP

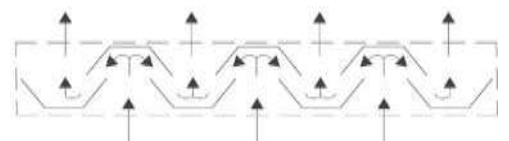

Filtro Inercial



ANVISA
Agência Nacional
de Vigilância Sanitária



HAYASHI
SYSTEM



ASSOCIAÇÃO
BRASILEIRA
DE NORMAS
TÉCNICAS



ASHRAE
Associate
Society
Alliance

Coifa Piramidal / Gourmet



Disponível nos modelos parede de Ilha



Coifa Piramidal / Gourmet

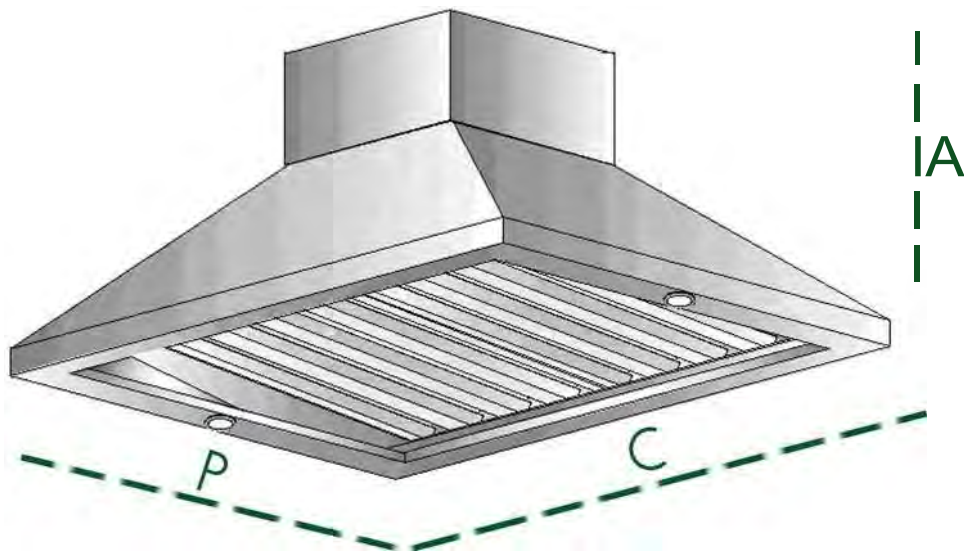

Dimensoes Minimas - COIFA GOURMET (parede/ilha)	
Altura (A)	700mm
Comprimento (C)	700mm
Profundidade (P)	700mm
Obs.As Coifas Gourmet podem ser feitas sob medida,consulte-nos.	

Componentes do Coifa Gourmet



Exaustor
Centrffugo

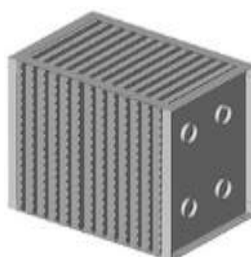

Filtro Eletrostático
ESP

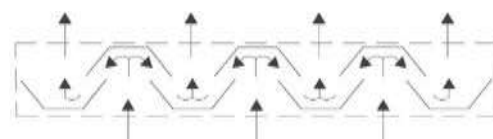

Filtro Inercial

CoifaVersatile

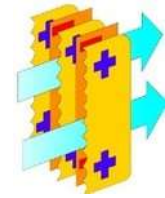

Lâminas com tecnologia Hayashi

Disponível no modelo de parede.



Coifa Versatile

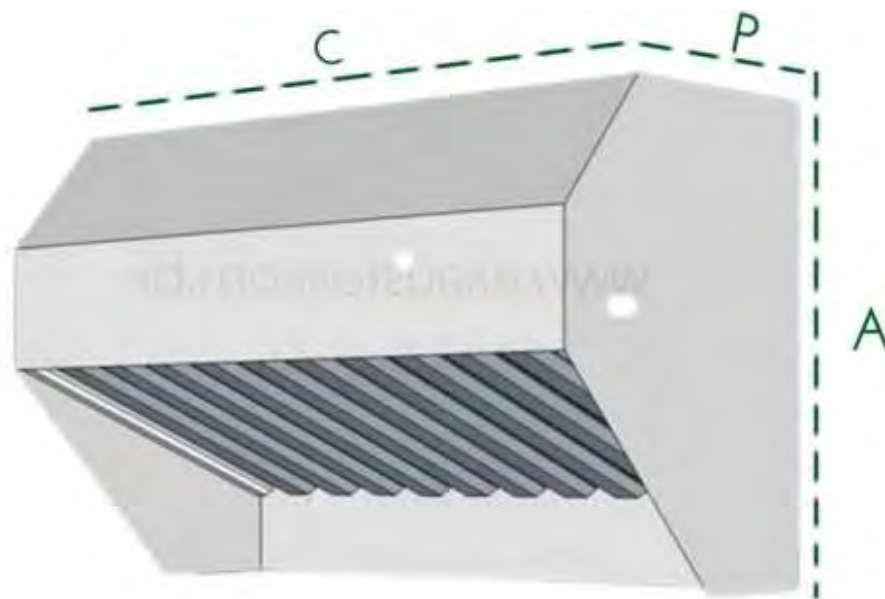

Dimensoes Minimias - COIFA VERSATILE (parede)	
Altura (A)	1100mm
Comprimento (C)	700 mm
Profundidade (P)	800 mm
Obs.As Coifas Versatile podem ser feitas sob medida, consulte-nos.	

Componentes da Coifa Versatile

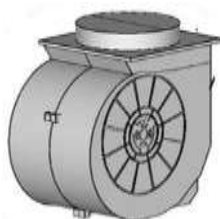

Exaustor
Centrífugo

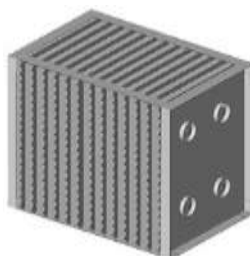

Filtro Eletrostático
ESP

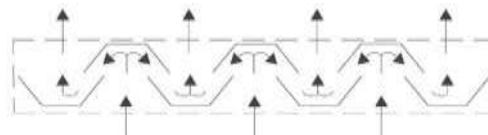

Filtro Inercial



Sistema Anti-Incendio

Aplicação

As cozinhas profissionais estão sujeitas a incêndios constantemente. Daí a necessidade da instalação de sistema de extinção de incêndio nas coifas e dutos.

Os estabelecimentos de economia múltiplas, shoppings, hotéis, centros comerciais e outros, devem possuir um sistema fixo de extinção de incêndio, conforme a norma IT 38 do Corpo de Bombeiros e a NBR 14518 da ABNT.



ANVISA
Agência Nacional
de Vigilância Sanitária



HAYASHI
SYSTEM



ASSOCIAÇÃO
BRASILEIRA
DE NORMAS
TÉCNICAS



ASHRAE
Associate
Society
Alliance



Se desejar iniciar uma conversa ligue:

(11) 93216-9701

Horário de atendimento:

De segunda a sexta, das 8:00h às 17:00h

Sábado, das 8:00h às 12:00h

Ou se preferir visite nosso Showroom

Escritório Central Rua Joao de Sousa Dias, 412 - Campo Belo São Paulo - SP



